

Multipurpose and portable winch



Pulley-man

Capacity 300 kg (600 kg double line)

**Its motor :
your own hand drill !**

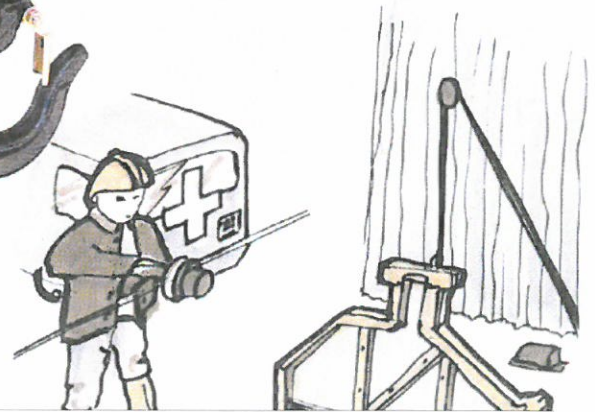
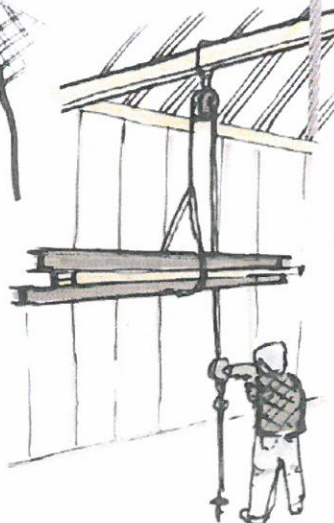
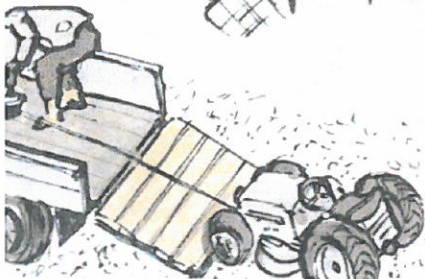
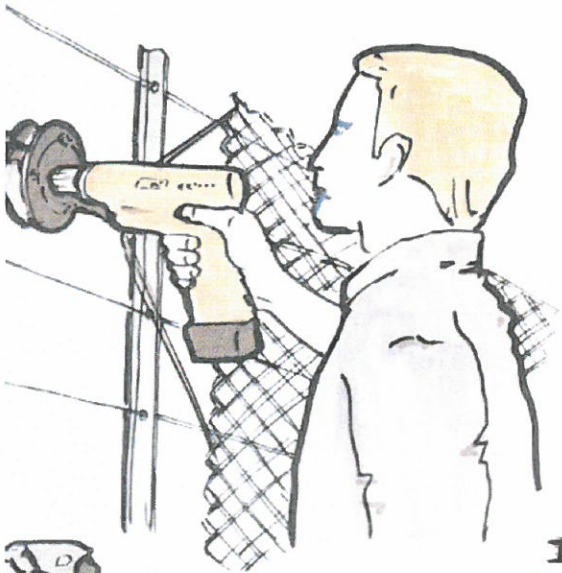

svealyft[®]

Svealyft AB, Box 9172, 200 39 Malmö. Tel: 040-22 12 90, Fax: 040-22 12 70
www.svealyft.se

Dimensions and technical data

Lifting or hauling winch

Capacity: 300 kg single line
600 kg double line

Easy installation and dismantling

Compact and light (3,5 kg)

Infinite working length (12 m supplied in standard)

- Powered by reversible hand drill or screwdriver
- Unlimited working distance
- Horizontal/vertical/slant working conditions by fixed mainbody or fixed wire hook method
- Trouble-free automatic holding-brake function (patented gear-reducer)
- Can do many jobs in any 360° rotating direction that you want
- Speed depending on screwdriver speed used
- Standard supplied with 12 m of aircraft galvanized steel rope \varnothing 4.76

Applications: electric and cable works, installation and maintenance teams, construction sites and industrial plants, carries agricultural, marine, dairy and forestry products, rescue works at sea, rivers, fires, military operations...

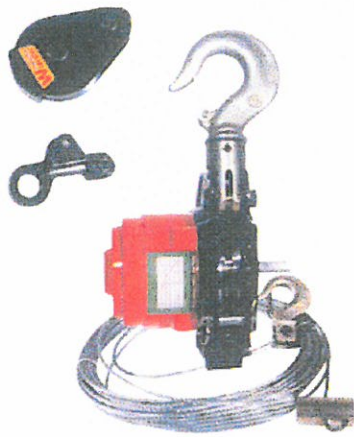
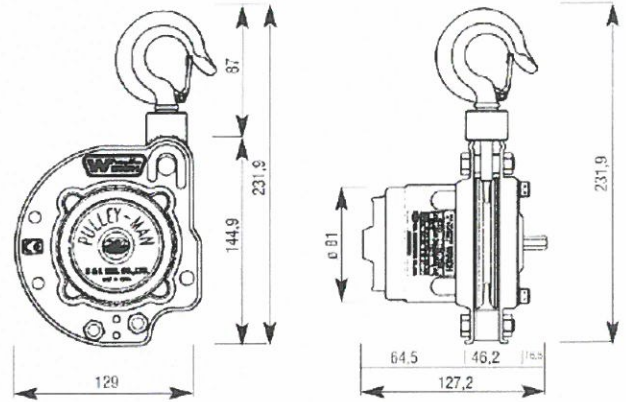

Demonstration set out

Fixed Pulley man method

Fixed wire hook method

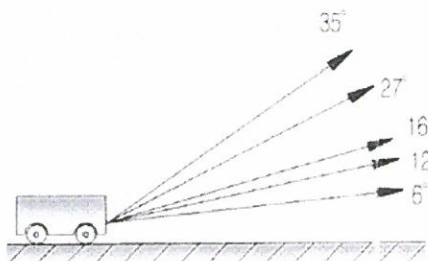
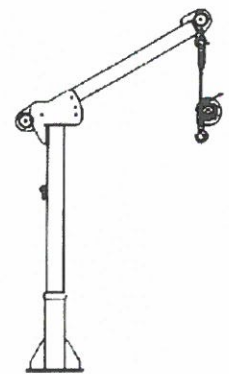
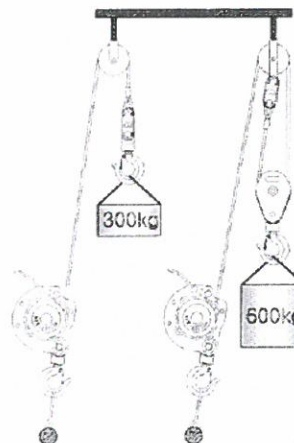
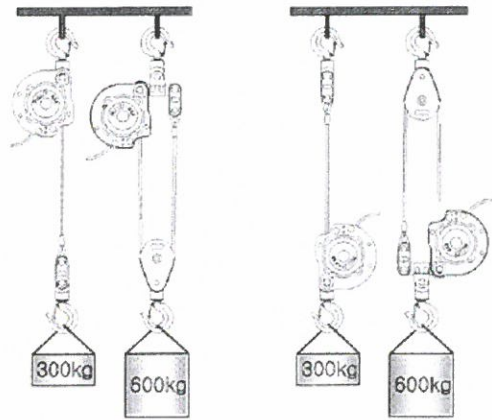

	Single line	Double line
Pulling capacity	6" 1500kg	3000kg
	12" 975kg	1950kg
	16" 625kg	1250kg
	27" 585kg	1170kg
	35" 450kg	900kg



svealyft[®]

Svealyft AB, Box 9172, 200 39 Malmö. Tel: 040-22 12 90, Fax: 040-22 12 70
www.svealyft.se